

# TRITON®

## THE MOST INTELLIGENT

HIGH EFFICIENCY COMMERCIAL GAS WATER HEATERS ON THE MARKET



TRITON® **LD**  
LIGHT DUTY

TRITON® **HD**  
HEAVY DUTY

TRITON® **SD**  
SUPER DUTY



*This product meets a stringent set of our internally defined sustainability standards.*





# YOU DEMAND. TRITON DELIVERS.

You want a water heater that offers the features you need to get things done—and the durability to keep your business up and running. The Triton® Family is more than a major advancement in water heating. It's an absolute game changer—because Triton offers a package of features and benefits no other high efficiency commercial gas water heater can.

## THE TRITON ADVANTAGE

- Eliminate the Emergency
- Easy Retrofit
- Built to Last

TRITON®

## The Most Intelligent High Efficiency Commercial Gas Water Heater on the Market, **Triton Eliminates the Emergency**

Triton's built-in intelligence helps eliminate business downtime.

- **LeakGuard™** – Prevents leaks with an all-inclusive detection system and proprietary auto water shut-off valve, limiting leakage to no more than 24 ounces<sup>1,2</sup>
- **LeakSense™** – Detects and alerts you to water leaks so you can deal with them before they become a problem
- **Advanced Diagnostics** – Ongoing systems monitoring including igniter, flame sensor, tank & combustion health
- **Preventive Maintenance Reminders** – Extend tank life with real-time service alerts for tank cleaning and condensate neutralizer medium replacement

FEATURE	TRITON SU	TRITON SS	COMPETITOR 1	COMPETITOR 2
LeakGuard™ Leak Detection & Prevention System With Auto Shut-Off Valve <sup>1</sup>	X	✓	X	X
LeakSense™ Integrated Leak Detection System	✓	✓	X	X
Integrated Monitoring With WiFi Mobile App	✓	✓	✓	X
Energy & Water Usage Reports <sup>1</sup>	X	✓	X	X
Full-Color LCD Monitoring Display	✓	✓	X	X
Systematic Health Alerts	✓	✓	X	X
Integrated BACnet Port	X	✓	X	X



## CONVENIENCE AND PEACE OF MIND

### EcoNet® Smart Monitoring Technology with Integrated WiFi



#### Smart Monitoring Technology

Monitors the unit's most vital components remotely on a mobile device via the EcoNet app<sup>3</sup>



#### Scheduling and Reporting

Features energy and water usage reporting to track trends and identify spikes from potential system issues

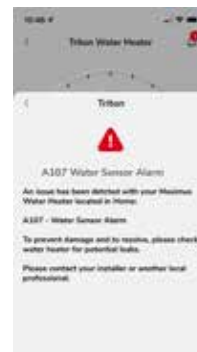

#### Preventative Maintenance Alerts

Provides more control with the ability to receive maintenance alerts and reminders for multiple sites via the EcoNet app



#### Detection and Prevention

Delivers leak detection alerts and allows the choice between shutting off the water or keeping it running until a replacement can be installed



# Designed for Versatility, Triton Makes for Easy Installation and Retrofit

Triton® is great for new construction, but it really shines in replacement applications.

## Designed to replace any other commercial gas water heater, Triton:

- Manifolds with any other brand of commercial gas water heater
- Features a total of four (Triton Light Duty) or five (Triton Heavy Duty and Triton Super Duty) water inlet and outlet connections for easy piping
- Offers compatibility with a variety of flexible venting options, including polypropylene, PVC, CPVC, InnoFlue® Flex Vent and ABS; installed in power direct and power vent configurations and can vent 2-, 3-, 4- (LD, HD and SD) and 6-inch (HD and SD) diameters
- Features a built-in condensate neutralizer, which eliminates the need for a separate device to raise the pH of the condensate for safe draining



Triton SD

## UNBALANCED & BALANCED VENTING ON DIFFERENT PLANES



### Triton Super Duty and Triton Heavy Duty Venting Options<sup>4</sup>

#### Competitive Comparison

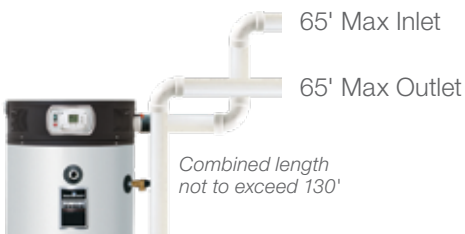
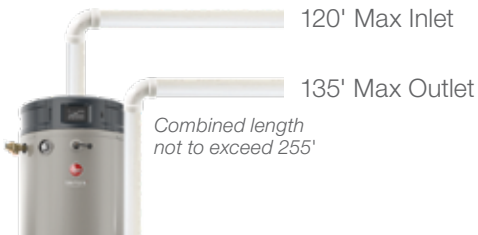

FEATURE	TRITON SD/HD SU	TRITON SD/HD SS	COMPETITOR 1	COMPETITOR 2
<b>Inlets</b>				
Side Front	✓	✓	✓	✓
Side Back	✓	✓	X	X
<b>Outlets</b>				
Side Front	✓	✓	X	✓
Side Back	✓	✓	X	X
Top	✓	✓	✓	X

FEATURE	TRITON SD/HD SU	TRITON SD/HD SS	COMPETITOR 1	COMPETITOR 2
Built-in Condensate Neutralizer	✓	✓	X	X
Flex Vent Options	✓	✓	X	X



Triton HD



Triton LD



## Triton Light Duty Venting Options

Competitive Comparison (3" Diameter)

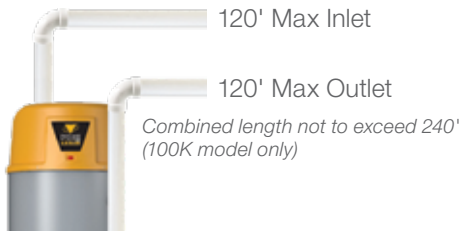

WATER CONNECTION POINTS	TRITON LD SU	TRITON LD SS	COMPETITOR 1	COMPETITOR 2
<b>Inlets</b>				
<b>Side Front</b>	✓	✓	✓ <i>(100K model only)</i>	✗
<b>Top</b>	✓	✓	✓	✓
<b>Outlets</b>				
<b>Side Front</b>	✓	✓	✓ <i>(100K model only)</i>	✗
<b>Top</b>	✓	✓	✓	✓

FEATURE	TRITON LD SU	TRITON LD SS	COMPETITOR 1	COMPETITOR 2
<b>Built-in Condensate Neutralizer</b>	✓	✓	✗	✗
<b>Flex Vent Options</b>	✓	✓	✗	✗



# TRITON SD/HD

Triton Super Duty and Triton Heavy Duty eliminate downtime for larger enterprises with higher hot water demands.



FEATURE	TRITON SD/HD SU	TRITON SD/HD SS	COMPETITOR 1	COMPETITOR 2
ASME-Grade Steel Heat Exchanger	✓	✓	✗	✗
Power Anode Rod	✓	✓	✓	✗
Full Modulation	✓	✓	✓	✗
Tank Warranty	3-Year	5-Year	3-Year	3-Year

From the patented triple pass heat exchanger to advanced modulation, Triton Super Duty and Heavy Duty deliver the durability and efficiency you need in a commercial water heater. **Triton water heaters are an investment that pays off day after day, year after year.**

- Porcelain/ glass coated, ASME grade steel minimizes corrosion and extends the life of the tank
- Modulation on both Triton Super Duty and Heavy Duty optimizes thermal efficiency and maximizes energy savings
- Built for durability Tritons are backed by a five-year warranty with select 200k-400k BTU/h models upgradeable to 15 years

## Power Anode Rod

All Triton water heaters feature self-adjusting, non-sacrificial power anodes that minimize corrosion and extend tank life. The on-unit display provides anode health and anode remaining life monitoring.

# TRITON LD

**Triton Light Duty is perfect** for small businesses that need a smarter, more robust solution than standard units.



## HELICAL COIL HEAT EXCHANGER

Internal diverter  
and porcelain-coated  
steel

FEATURE	TRITON LD SU	TRITON LD SS	COMPETITOR 1	COMPETITOR 2
PV or PDV	✓	✓	X	X
Power Anode Rod	✓	✓	✓	X
Built-in Condensate Neutralizer	✓	✓	X	X
Tank Warranty	3-Year	5-Year	3-Year	3-Year

Triton Light Duty's patented combustion system and helical coil heat exchanger provide maximum thermal efficiency and durability to keep your business running smoothly. **Now smaller business can benefit from full Triton features in a compact size.**

- Helical coil heat exchanger offers maximum thermal efficiency and energy savings
- Porcelain/ glass-coated steel minimizes corrosion and extends the life of the tank
- Unique minimum weld joint construction increases durability



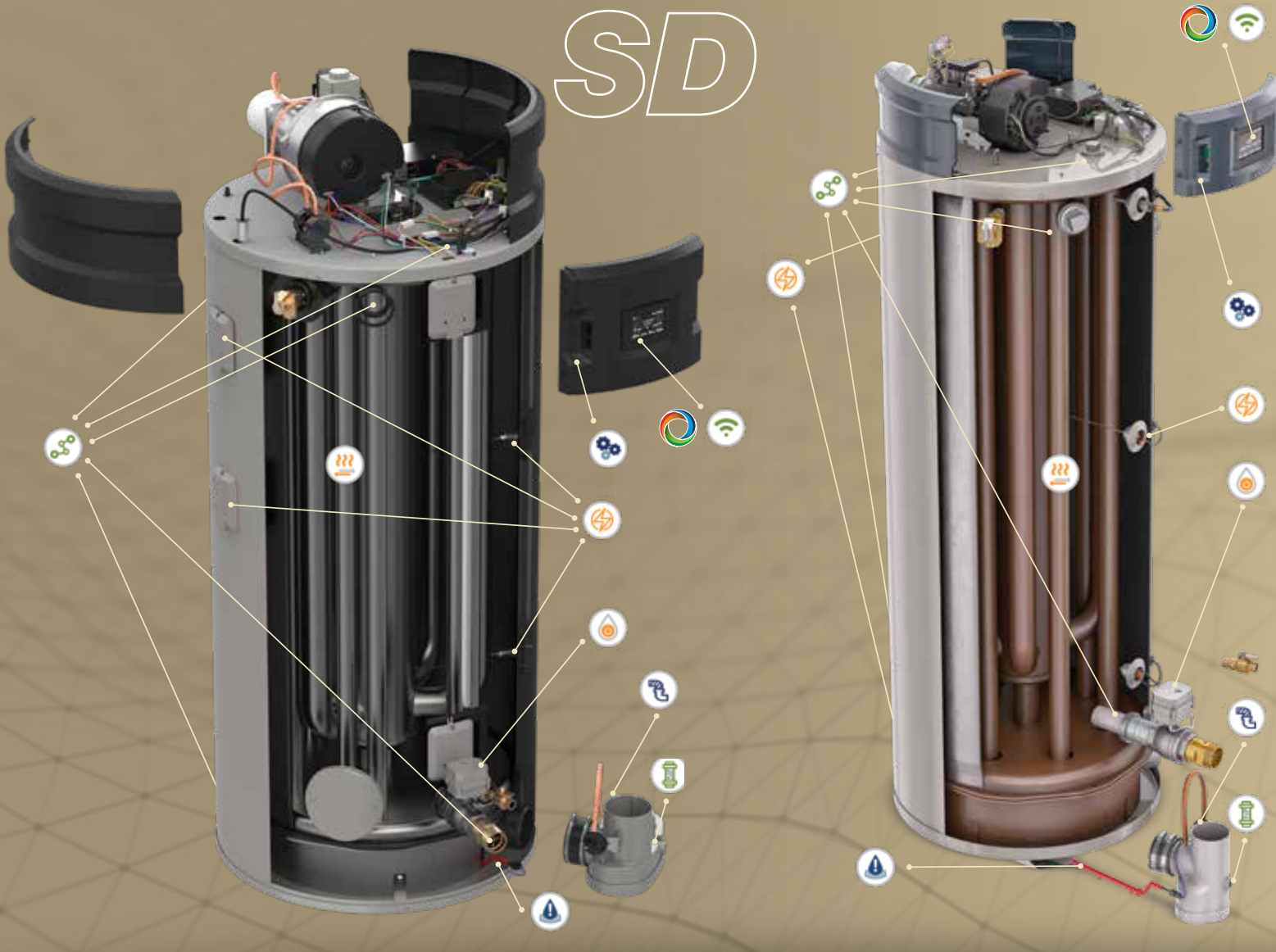

## Designed for the End User—and You

### Triton Product Features

During the development of Triton®, we met with people who sell, install and use commercial water heaters. Armed with their input, Rheem® engineers perfected a design that would prove to be the ideal solution. **And thus, the era of Triton has begun.**

## Built-in Intelligence



### LeakGuard™

All-inclusive leak detection and prevention system with proprietary auto shut-off valve limits leakage to no more than 24 ounces of water (SS models only)



### LeakSense™

Intelligent leak detection system catches leaks as small as a grain of sand and provides real-time leak notifications



### EcoNet® Smart Monitoring Technology With Integrated WiFi

Exclusive technology provides performance updates and alerts via both mobile device and full-color LCD display



### Integrated BMS Connectivity Via BACnet (MS/TP)

Built-in BACnet port easily connects to building management systems (BMS) (SS models only)





# HD

# LD



## TRITON SS EXCLUSIVES

### STANDARD FEATURES OF THE TRITON SU BASE MODEL, PLUS:

- LeakGuard™
- Integrated BMS Connectivity via BACnet (MS/TP)
- Energy & Water Usage Reports
- 5-Year Warranty (extendable to 15 on 200-400K BTU/h models)

## TRITON SS AND SU

- 76K-100K BTU/h (Light Duty)
- 130K-500K BTU/h (Heavy & Super Duty)
- LeakSense™
- Easy Retrofit Across Brands
- Health Alerts
- Built-in Condensate Neutralizer
- Integrated EcoNet® Smart WiFi Monitoring Technology
- Scheduling Capability
- Advanced Power Anode (4) on SD | (3) on HD & LD
- 3-Year Warranty

## Easy Installation or Replacement



### Multiple Connection Points

Multiple water connections: top (1), front (2) and back (2) for SD & HD; top (2) and side (2) for LD



### Variety of Venting Options

Ideal for replacement and new installs with a selection of the most flexible venting choices



### Patented Built-in Condensate Neutralizer

Built-in condensate neutralizer reduces water acidity or safe drainage at no additional cost

## Built to Last Five Years Longer



### Triple-Pass Heat Exchanger

Constructed with premium **ASME-grade steel** to minimize rust and corrosion for extended tank life and maximum thermal efficiency (Triton HD & SD only)



### Helical Coil Exchanger

Porcelain/glass-coated steel minimizes corrosion for extended tank life and maximum thermal efficiency. Internal diverter increases durability (Triton LD only)



### Advanced Power Anodes

Self-adjusting, non-sacrificial power anodes provide systematic monitoring of anode health and present remaining life on full-color LCD unit display



# TRITON SD/HD

## Specifications

MODEL NUMBER	A	B	C	D	E	F	G	H	I	VENT	SIDE WATER CONNECTION	TOP OUTLET
											INLET/OUTLET	
GHE80SU/SS-130(A)	67-7/8"	57.43"	26-3/8"	13"	12-1/2"	60-1/2"	10-5/8"	63-5/8"	70-1/16"	2", 3", 4"	2" NPT	1.5" NPT
GHE80SU/SS-160(A)	67-7/8"	57.43"	26-3/8"	13"	12-1/2"	60-1/2"	10-5/8"	63-5/8"	70-1/16"	2", 3", 4"	2" NPT	1.5" NPT
GHE80SU/SS-200(A)	67-7/8"	57.43"	26-3/8"	13"	12-1/2"	60-1/2"	10-5/8"	63-5/8"	70-1/16"	2", 3", 4"	2" NPT	1.5" NPT
GHE80SU/SS-300(A)	67-7/8"	57.43"	26-3/8"	13"	12-1/2"	60-1/2"	10-5/8"	63-5/8"	70-1/16"	3", 4", 6"	2" NPT	1.5" NPT
GHE100SU/SS-130(A)	77"	66-3/4"	26-3/8"	13"	12-1/2"	69.80"	10-5/8"	72-3/4"	77-1/2"	2", 3", 4"	2" NPT	1.5" NPT
GHE100SU/SS-160(A)	77"	66-3/4"	26-3/8"	13"	12-1/2"	69.80"	10-5/8"	72-3/4"	77-1/2"	2", 3", 4"	2" NPT	1.5" NPT
GHE100SU/SS-200(A)	77"	66-3/4"	26-3/8"	13"	12-1/2"	69.80"	10-5/8"	72-3/4"	77-1/2"	2", 3", 4"	2" NPT	1.5" NPT
GHE100SU/SS-250(A)	77"	66-3/4"	26-3/8"	13"	12-1/2"	69.80"	10-5/8"	72-3/4"	77-1/2"	3", 4", 6"	2" NPT	1.5" NPT
GHE100SU/SS-300(A)	77"	66-3/4"	26-3/8"	13"	12-1/2"	69.80"	10-5/8"	72-3/4"	77-1/2"	3", 4", 6"	2" NPT	1.5" NPT
GHE100SU/SS-400(A)	77"	66-3/4"	26-3/8"	13"	12-1/2"	69.80"	10-5/8"	72-3/4"	77-1/2"	3", 4", 6"	2" NPT	1.5" NPT
GHE119SU/SS-500(A)	78-1/4"	63-5/8"	32-1/4"	11-1/2"	11"	65"	8-3/4"	73-1/8"	71-1/4"	3", 4", 6"	2" NPT	1.5" NPT

0" clearance to all combustible surfaces on sides and back; 6" for top.  
 \*applicable to Triton SD only.

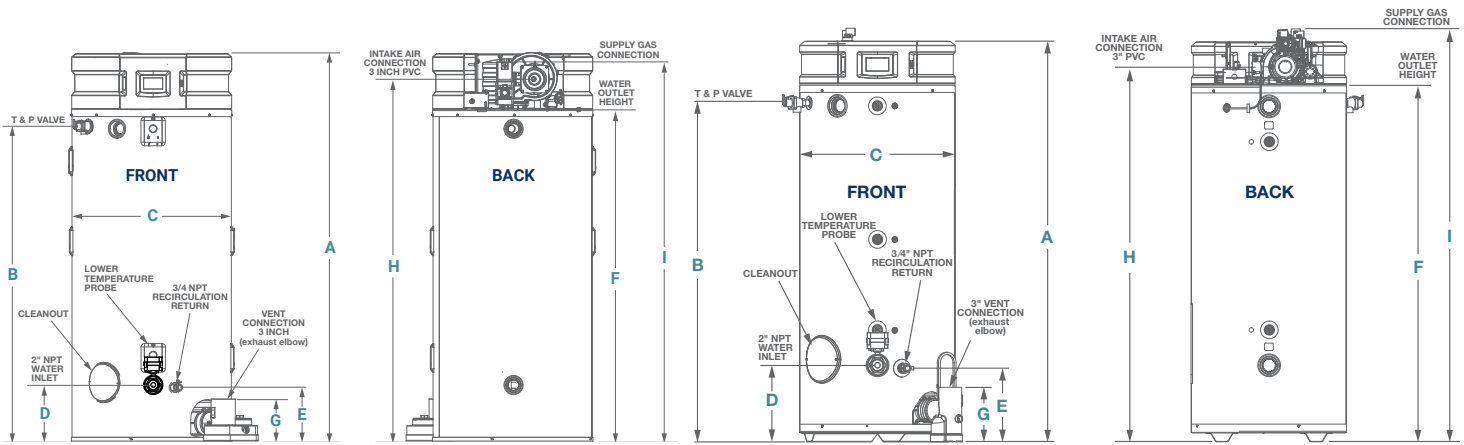

Feet not included on SD models to limit height.

# TRITON LD

## Specifications

### DIMENSIONAL INFORMATION

MODEL NUMBER	A	B	C	D	E	F	G	H	I	J	K	L	M	N
GHE50SU/SS-76	64-1/2	48	21-3/4	3	15-1/4	55-1/8	9	62-3/4	60-3/16	48	12	5-3/4	39-1/2	27-3/4
GHE50SU/SS-100	64-1/2	48	21-3/4	3	15-1/4	55-1/8	9	62-3/4	60-3/16	48	12	5-3/4	39-1/2	27-3/4
GHE75SU/SS-100	62-1/4	46-3/4	26-1/4	3-1/4	15-7/8	55-1/8	9	62-5/8	60-1/8	46-3/4	12	5-3/4	40-3/4	34-1/4

0" Clearance to all combustibile surfaces on sides and back; 15" for top.

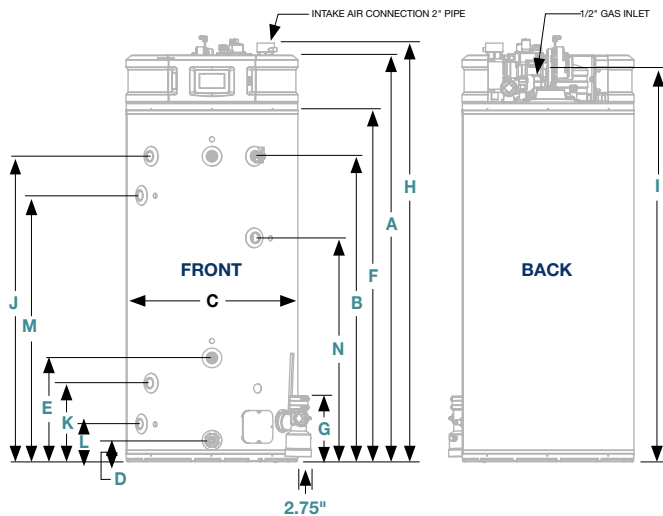

### COMMERCIAL SIZING SOLUTIONS

Get the sizing and selection information you need for your commercial project

#### SIZE IT YOURSELF

[RapidSpec.com](https://www.rapid-spec.com)

#### GET IT SIZED

by Rheem® Applications Engineers

[rheem.com/application-form](https://www.rheem.com/application-form)



# WHY RHEEM COMMERCIAL?

Building on nearly a century of innovation, the Rheem® Triton® Line is the next step in our evolution—commercial water heating solutions designed to provide the hot water you need to keep your business up and running. And behind every Triton is the support of the commercial experts at Rheem.



## BIM Support

More accurately design and estimate cost for jobs in less time with compatible spec data, 2D and 3D CAD® files and Revit® files.



## Proprietary Selection Tool Software

We offer smart selection tools to help you specify, select and document all Rheem equipment for new construction or replacement in all commercial applications. Visit [RapidSpec.com](http://RapidSpec.com) to learn more about RapidSpec, our comprehensive commercial sizing tool.



## Sizing Support

Rheem Applications Engineers are standing by to help you determine the right product mix for your next project. Visit [rheem.com/application-form](http://rheem.com/application-form) to get in touch with our sizing pros.



## Industry's Fastest Lead Time

Our vast distribution network across the US and Canada means improved factory lead times to help avoid business downtime.



## Dedicated Technical Support

From our dedicated support team to resources such as [My.Rheem.com](http://My.Rheem.com), [RheemTraining.com](http://RheemTraining.com), our Innovation Learning Centers, live product assistance and more, Rheem is here to support you at every step.

## Contact Us

**Customer Service, Warranty and Parts: 800.621.5622**

**Technical Service: 800.HEATER3 (800.432.8373)**

**EcoNet® Support: 866.339.2388**

**Plumber Support Group: 866.339.2388**

<sup>1</sup>Applies to SS models only. <sup>2</sup>Source: Rheem Leak-Sensing Data Review; testing under a vacuum using a 50-gallon, no-expansion tank with average tank pressure of 50 PSI. <sup>3</sup>WiFi broadband connection and EcoNet App required; notifications are dependent on external factors beyond Rheem's control. EcoNet Screens are subject to change without notice. <sup>4</sup>Based on 200,000 BTU/h – 4" pipe. <sup>5</sup>Source: According to the U.S. Department of Energy, a commercial water heater is expected to last seven years. Test data shows Triton is rated to last 12 years. <sup>6</sup>Applies to 200–400K BTU/h Triton Heavy Duty SS models.



[Rheem.com/Triton](http://Rheem.com/Triton)

